

UPS **MILITARY** **FIELD-GRADE**

Uninterruptible Power Supply



Smaller

Lighter

More Powerful

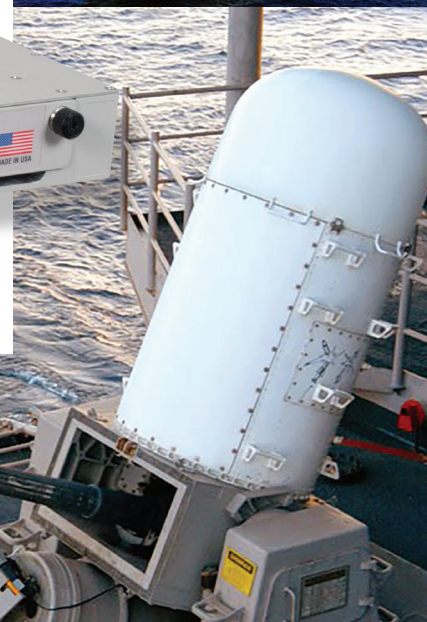

Sealed Weather-Proof Construction

SynQor[®]

UPS **MILITARY** **FIELD-GRADE** Uninterruptible Power Supply

SynQor's Military Field-Grade Uninterruptible Power Supply units are designed for the extreme environmental and demanding electrical conditions of Military/Aerospace applications. SynQor's UPS incorporates field proven high efficiency designs and rugged packaging technologies. SynQor's UPS units will accept a wide range of input voltage and frequency values while delivering a well-conditioned AC or DC output to the load. The use of lithium ion batteries permits the lowest profile and lowest weight solution in its power class. It is designed and manufactured in SynQor's USA facilities to comply with a wide range of military standards. Options include two DC outputs, a DC input rated for military 28 VDC sources, and an electronic breaker on the AC output to permit fault-tolerant parallel operation for higher power and/or N+M systems.

UPS AC & DC PRODUCT FEATURES

- ◆ Sealed, weather-proof, shock-proof construction
- ◆ Military Tough, Die-Cast Aluminum Chassis
- ◆ 1250W-1500VA; 2500W-3000VA output power
- ◆ >10 minute run-time at full power
- ◆ Full power operation -20°C to +55°C (Storage: -40°C to +65°C)
- ◆ Hot swappable internal battery pack (lithium ion)
- ◆ Universal AC input: 80-265VAC; 47-65Hz
- ◆ Dual input: AC and optional DC
- ◆ True on-line double conversion
- ◆ Cold-start with no AC or DC input connections
- ◆ Power factor correction at AC input
- ◆ Pure sinusoidal AC output voltage (115VAC, 60Hz)
- ◆ Handles 0.0—1.0 power factor loads and non-linear loads
- ◆ User I/O and Configuration signal ports
- ◆ Up to 3 units can be combined for higher power, voltage or a 3-Phase AC output
- ◆ Up to 32 units can be combined to form a higher power, fault-tolerant, glitch-free system, perhaps with N+M redundancy, by ordering with the "AC Output Electronic Breaker" option and the appropriate configuration cable

OPTIONS

- ◆ DC input (28Vnom) for dual source
- ◆ UPS-1250/1500-H-1U >13.5 minutes of run-time
- ◆ UPS-1250/1500-M-1U >16 minutes of run-time and -40°C operation
- ◆ Wide-range AC input frequency: 47Hz to 800Hz
- ◆ 3-Phase AC input: 85-140V_{RMS L-N} (147-242V_{RMS L-L})
- ◆ 115Vrms or 230Vrms AC output
- ◆ 50Hz, 60Hz, or 400Hz output
- ◆ DC1: Auxiliary isolated DC output (up to 500W each)
- ◆ DC2: High power DC output parallelable for higher power (UPS-1500 up to 1250W; UPS-3000 up to 2500W)
- ◆ Total AC & DC1 & DC2 output power UPS-1500 = 1250W
- ◆ Total AC & DC1 & DC2 output power UPS-3000 = 2500W
- ◆ Shipboard version with floating neutral wire
- ◆ Rack mounting style
- ◆ N+1 redundancy

SPECIFICATION COMPLIANCE

- UPS units are designed to meet:**
- ◆ MIL-STD-461F - Electromagnetic Interference
 - ◆ MIL-STD-704F - Aircraft Electrical Power
 - ◆ MIL-STD-810G - Environmental Engineering
 - ◆ MIL-STD-1275D - Vehicle Electrical Power
 - ◆ Mil-STD-1399-300B - Interface Shipboard

BLOCK DIAGRAM

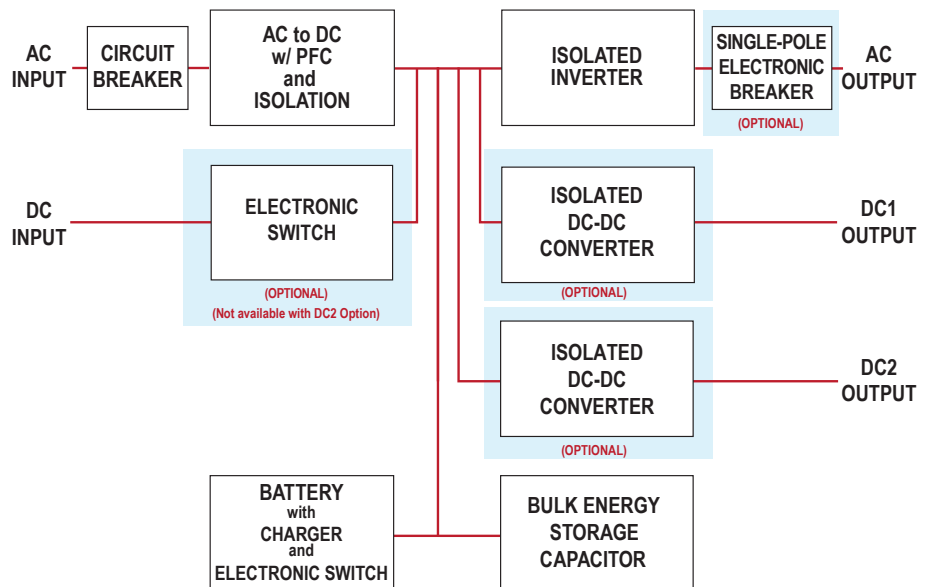

SynQor products are available in a variety of rack mounting and extended battery configurations. See the website for data sheets with more details.

AC & DC Output Base Model Number	Power	Battery Run-Time@Full Power (80% Power)	Height (W x D x H)	Weight
UPS-1500-S-1U (1 BAT-0200-S Pack)	1250 W 1500 VA	>10 min. (>13 min.)	1U (17.00" x 21.60" x 1.73")	32 lbs.
UPS-1500-H-1U (1 BAT-0400-H Pack)	1250 W 1500 VA	>13.5 min. (>18 min.)	1U (17.00" x 21.60" x 1.73")	33.8 lbs.
UPS-1500-M-1U (1 BAT-0400-M Pack)	1250 W 1500 VA	>16 min. (>22 min.)	1U (17.00" x 21.60" x 1.73")	33.8 lbs.
UPS-3000-S-2U (2 BAT-0200-S Packs)	2500 W 3000 VA	>10 min. (>13 min.)	2U (17.00" x 22.22" x 3.40")	65 lbs.
UPS-3000-H-2U (2 BAT-0400-H Packs)	2500 W 3000 VA	>13.5 min. (>18 min.)	2U (17.00" x 22.22" x 3.40")	68.6 lbs.
UPS-3000-M-2U (2 BAT-0400-M Packs)	2500 W 3000 VA	>16 min. (>22 min.)	2U (17.00" x 22.22" x 3.40")	68.6 lbs.

AC & DC Output Base Models	AC Input Freq	AC Output Voltage	AC Output Neutral Wire	AC Output Set Point Freq	DC Input / DC2 Output	DC1 Output	Additional Options
UPS-1500-S-1U- UPS-1500-H-1U- UPS-1500-M-1U- UPS-3000-S-2U- UPS-3000-H-2U- UPS-3000-M-2U-	L W	1 2	G F R	5 6 4	S D M P R V W	00 12 15 24 28 40 50	-E 00 CE

Not all combinations make valid part numbers, please contact SynQor for availability. See the Product Summary web page for more options.

***Notes:**

Order "F: Floating" option when configuring the AC output for multi-unit combinations of up to 3 units.

Order "R: AC Output Electronic Breaker" option for fault-tolerant, glitch-free parallel systems of up to 32 units with N+M redundancy. The AC output neutral wire will not be connected to the chassis.

Examples:

UPS-1500-H-1U-L1G6D28-E00, UPS-1500-M-1U-L2G5S00-E00

UPS-1500-S-1U-L2G5S00-ECE (230 V output with CE marking)

AC Input Freq	L 47-65 Hz W 47-800 Hz
AC Output Voltage	1 115 Vrms 2 230 Vrms
AC Output Neutral Wire	G Grounded F Floating* R AC Output Electronic Breaker*
AC Output Set Point Freq	5 50 Hz 6 60 Hz 4 400 Hz
DC Input / DC2 Output	S Not Installed D DC Input M DC2 Out 24 VDC with Droop Share P DC2 Out 24 VDC No Share R DC2 Out 28 VDC with Droop Share V DC2 Out 28 VDC No Share W DC2 Out 50 VDC No Share
DC1 Output	00 None 12 12 V 15 15 V 24 24 V 28 28 V 40 40 V 50 50 V
Additional Options	-E Ethernet/SNMP with Configuration Loading 00 No CE Marking CE CE Marking

DC Output Only Base Model Number	Power	Battery Run-Time@Full Power (80% Power)	Height (W x D x H)	Weight
UPS-1250-S-1U (1 BAT-0200-S Pack)	1250 W	>10 min. (>13 min.)	1U (17" x 22.25" x 1.73")	33 lbs.
UPS-1250-H-1U (1 BAT-0400-H Pack)	1250 W	>13.5 min. (>18 min.)	1U (17" x 22.25" x 1.73")	34.8 lbs.
UPS-1250-M-1U (1 BAT-0400-M Pack)	1250 W	>16 min. (>22 min.)	1U (17" x 22.25" x 1.73")	34.8 lbs.

DC Only Output Base Models	AC Input Freq	DC Regulation Type	DC Output Voltage	DC Input	Additional Options
UPS-1250-S-1U- UPS-1250-H-1U- UPS-1250-M-1U-	L W	R	24 28 48	D00	-E 00 CE

Not all combinations make valid part numbers, contact SynQor for availability. See the Product Summary web page for more options.

Examples: UPS-1250-S-1U-LR28D00-000, UPS-1250-H-1U-WR28D00-E00, UPS-1250-M-1U-LR28D00-0CE (with CE mark)

AC Input Freq	L 47-65 Hz W 47-800 Hz
DC Regulation	R Fully Regulated
DC Output	24 24 V Output 28 28 V Output 48 48 V Output
DC Input	D00 DC Input
Additional Options	-E Ethernet/SNMP 00 No CE Marking CE CE Marking

High Voltage Adjustable DC Output Model Number	Power	Battery Run-Time@Full Power (80% Power)	Height (W x D x H)	Weight
UPS-1250-S-1U (1 BAT-0200-S Pack)	1250 W	>10 min. (>13 min.)	1U (17" x 21.60" x 1.73")	32 lbs.
UPS-1250-H-1U (1 BAT-0400-H Pack)	1250 W	>13.5 min. (>18 min.)	1U (17" x 21.60" x 1.73")	33.8 lbs.
UPS-1250-M-1U (1 BAT-0400-M Pack)	1250 W	>16 min. (>22 min.)	1U (17" x 21.60" x 1.73")	33.8 lbs.

High Voltage Adjustable DC Output Base Models	AC Input Freq	DC3 Output	DC Input/DC2 Output	DC1 Output	Additional Options
UPS-1250-S-1U- UPS-1250-H-1U- UPS-1250-M-1U-	L W	270	S D M P R V W	00 12 15 24 28 40 50	-E 00

Not all combinations make valid part numbers, please contact SynQor for availability. See the Product Summary web page for more options.

Examples:

UPS-1250-S-1U-L270S12-E00,

UPS-1250-M-1U-L270D00-E00

AC Input Frequency	L 47-65 Hz W 47-800 Hz
DC3 Output	270 270 V Default, 150-325 VDC
DC Output Voltage	S Not Installed D DC Input M DC2 Out 24 VDC with Droop Share P DC2 Out 24 VDC No Droop Share R DC2 Out 28 VDC with Droop Share V DC2 Out 28 VDC No Droop Share W DC2 Out 50 VDC No Droop Share
DC Input/DC2 Output	00 None 12 12 V 15 15 V 24 24 V 28 28 V 40 40 V 50 50 V
Additional Options	-E Ethernet/SNMP with Configuration Loading 00 No CE Marking

UPS-1500-1U



UPS-1500-1U WITH DC INPUT/DC1 OUTPUT

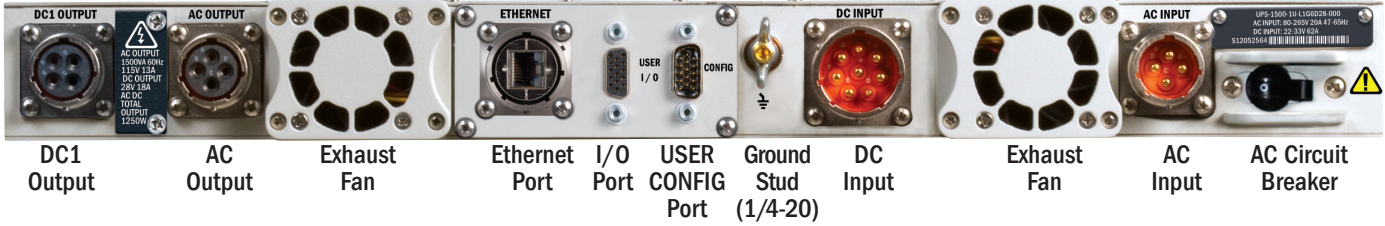

UPS-1500-1U WITH DC1 OUTPUT/DC2 OUTPUT

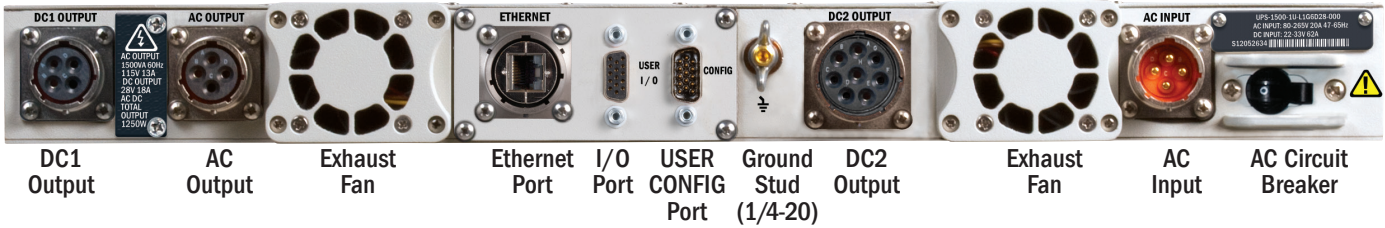

UPS-3000-2U



UPS-3000-2U WITH DC INPUT / DC1 OUTPUT

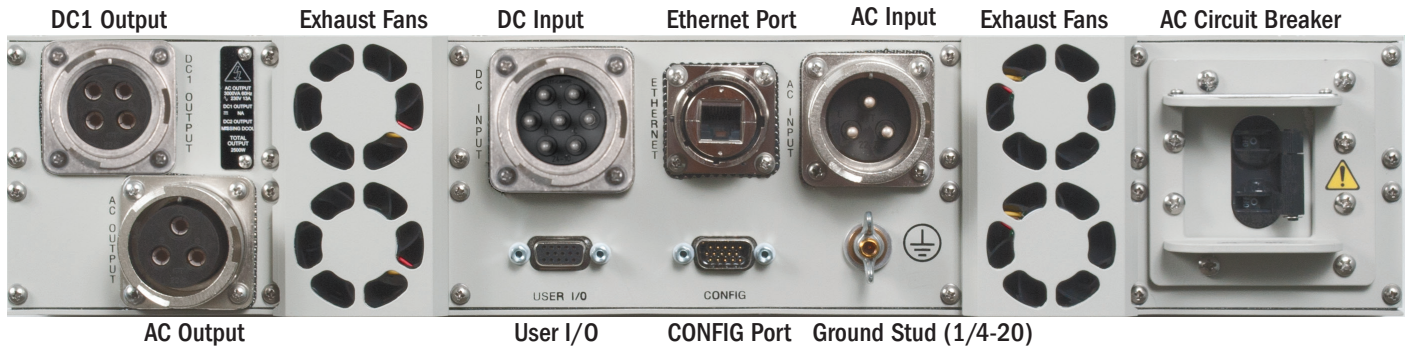

UPS-3000-2U WITH DC1 OUTPUT / DC2 OUTPUT

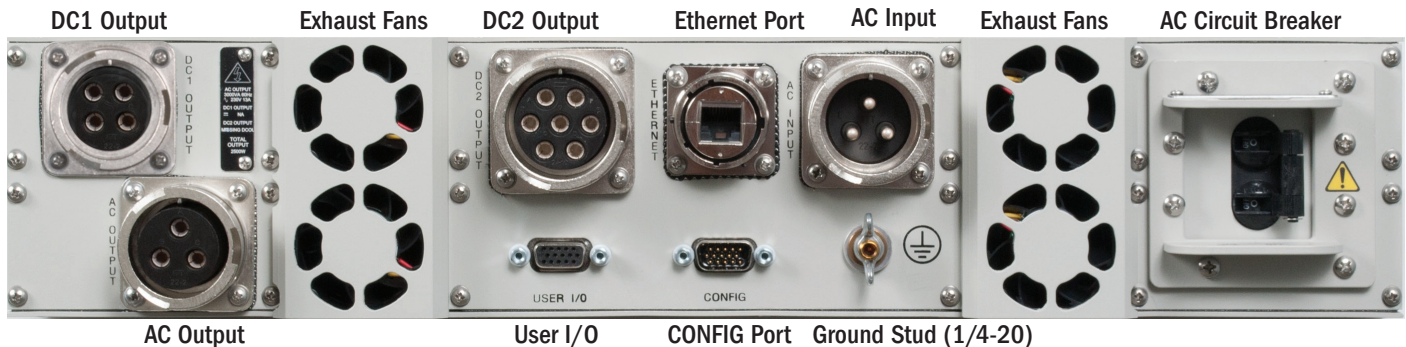

UPS-1500-1U

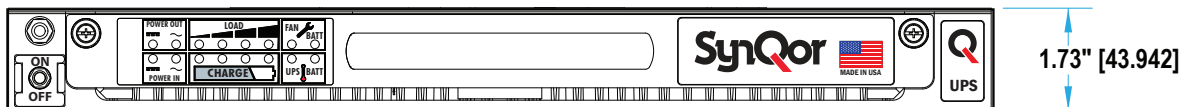
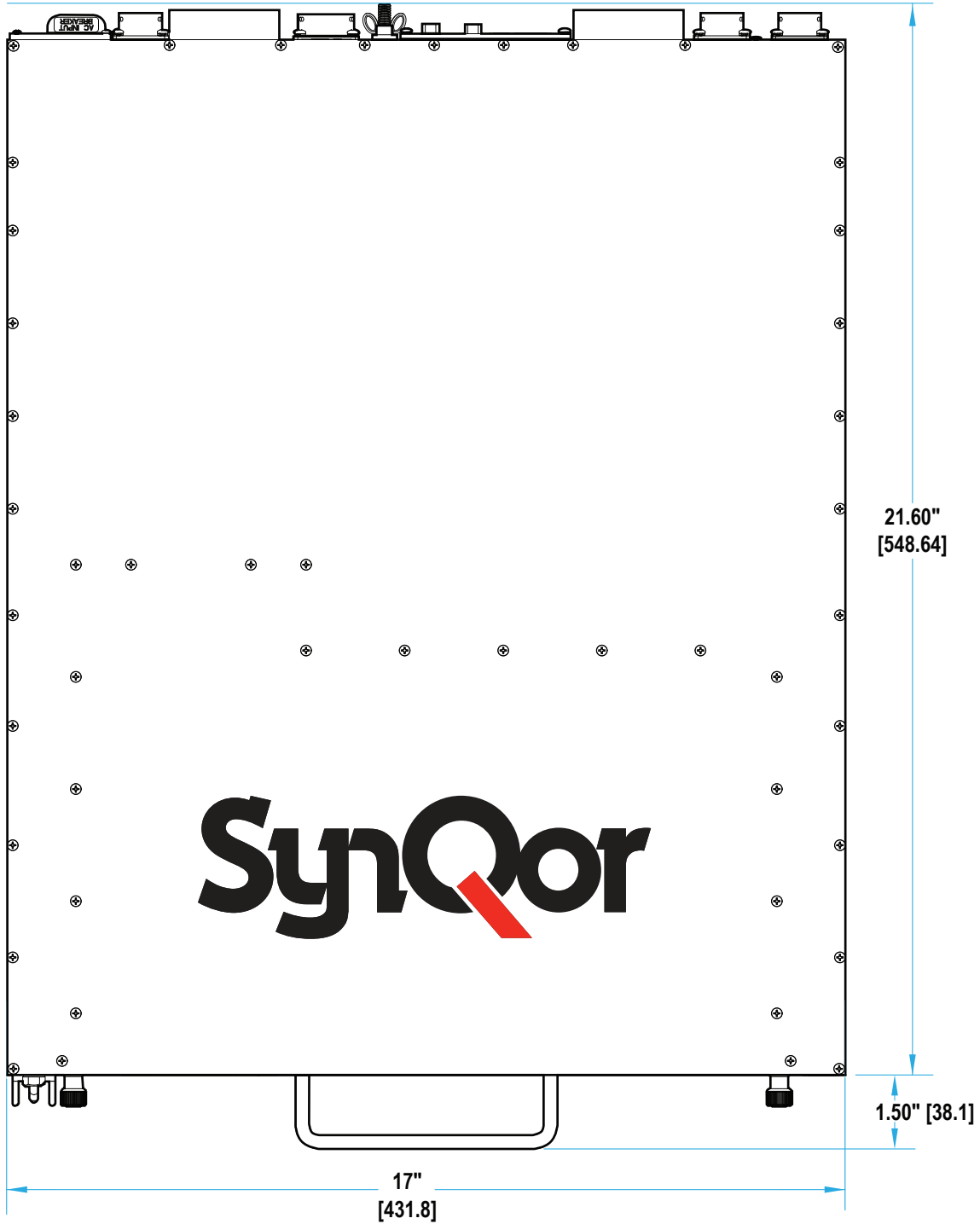

UPS-3000-2U

